



Continuous Emission Monitoring

DCEM2000/2100 Opacity/Dust Monitor

In-situ, low maintenance devices for continuous monitoring of opacity/dust emissions

- % opacity or dust density in mg/Nm^3
- Dual-pass, open-path transmissometer
- Integral auto zero and span check
- Dynamic misalignment check
- Full contamination check on all active optical surfaces
- Integral high efficiency air curtains for maximum uninterrupted service



DCEM2000/2100 Opacity/Dust Monitor

The DCEM2000 and DCEM2100 provide a continuous measurement of opacity or dust concentration in flue gases by continuously measuring the transmissivity of visible light across a process duct or stack.

Its dual-pass optical arrangement is based on twin transmissometers measuring in opposing directions through the same section of the gas stream, providing not only an accurate average of the dust loading, but also providing a unique dynamic assessment of any misalignment errors due to stack movement.

The measurement of opacity or particulate (dust) emissions from a process stack by measuring changes in optical transmission is simple in concept, the monitor must be insensitive to any other factors that degrade the optical transmission such as contamination of optical surfaces or gross misalignment.



DCEM2000/2100 monitors

Conventional Transmissometer vs DCEM2000/2100

Purge air failure

Power or purge air failure can allow hot, corrosive gases to flow back to the instrument and vent through the purge blower. This can result in catastrophic failure of the system.

vs

An integral ball valve mounted between each transceiver and its air purge acts as an automatic shut off valve which closes on loss of power or purge air.

Contamination

Many devices only measure optical contamination at the transceiver. They cannot measure contamination on the reflecting mirror on the opposite side of the stack. Many factors ensure that these surfaces often have different levels of contamination.

vs

A retro mirror mounted on the ball of each auto shut off valve can be automatically rotated into and out of the optical path of each transceiver. This enables the individual window contamination to be measured and corrected for each transceiver and individual compensation applied.

Misalignment

Although some systems provide the facility to manually detect misalignment, they cannot detect misalignment automatically. If there is duct movement, or the instrument is inadvertently misaligned, it may result in significant errors over an undefined period.

vs

Optical transmissivity is measured simultaneously in opposite directions over the same gas path using identical transceivers. When optical alignment is correct these measurements are identical. Any optical misalignment produces different transmissivities. The analyser automatically detects this and raises an alarm.

Dust density

Many instruments only provide a simple measurement of opacity. Opacity is not proportional to dust density.

vs

The outputs can be expressed in % opacity and dust density in mg/m³ or mg/Nm³ (corrected to Standard O₂, temperature, pressure and H₂O).



Signal Processor Unit (SPU)



Data Display Unit (DDU)

The DCEM2000/2100 incorporates unique features that resolve each of these problem issues, resulting in an instrument that surpasses the performance of all previous opacity monitors.

DCEM2000 Dust/Opacity Monitor - SmartCEM Integrated System Arrangement

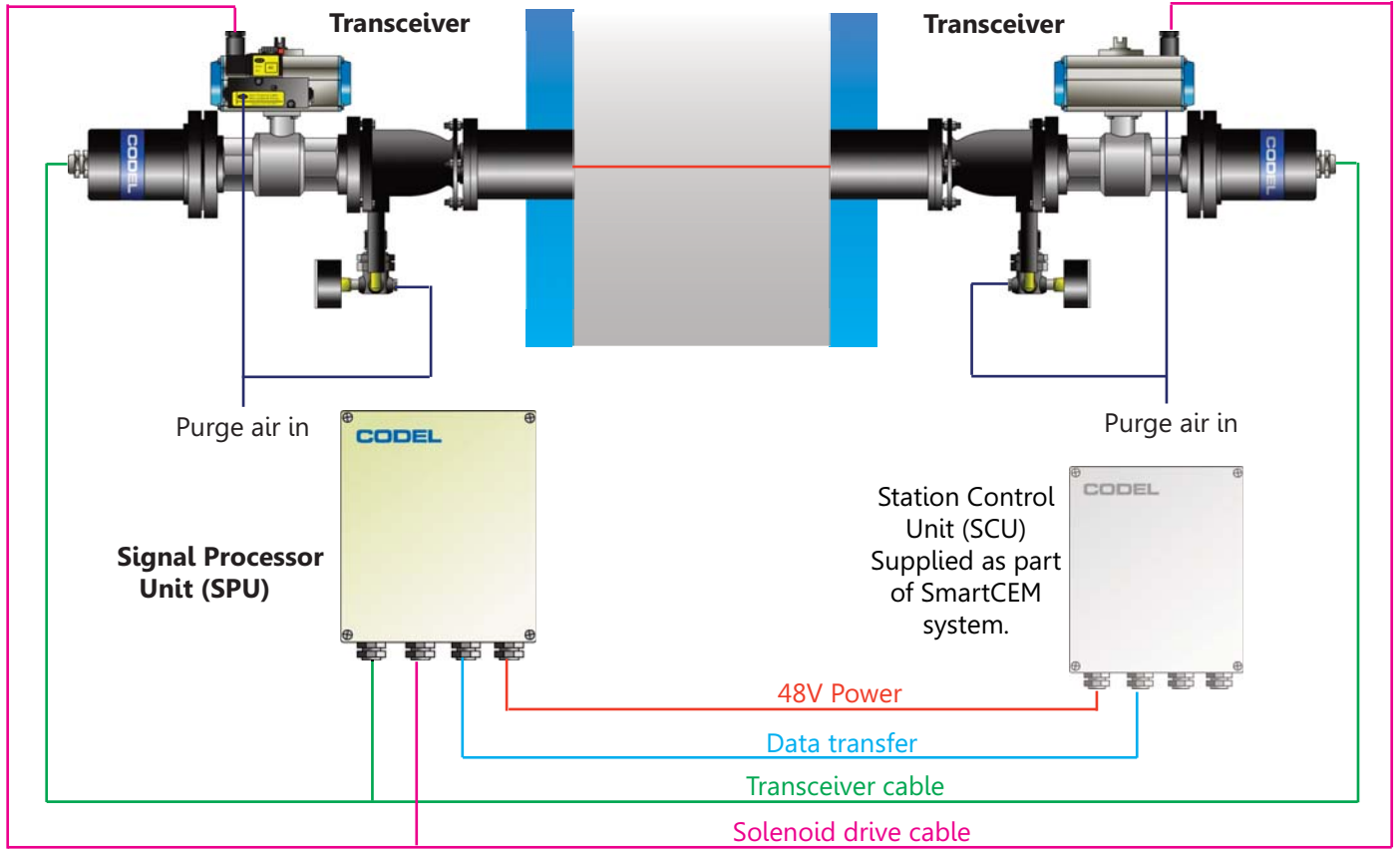

DCEM2100 Dust/Opacity Monitor - Stand Alone System Arrangement

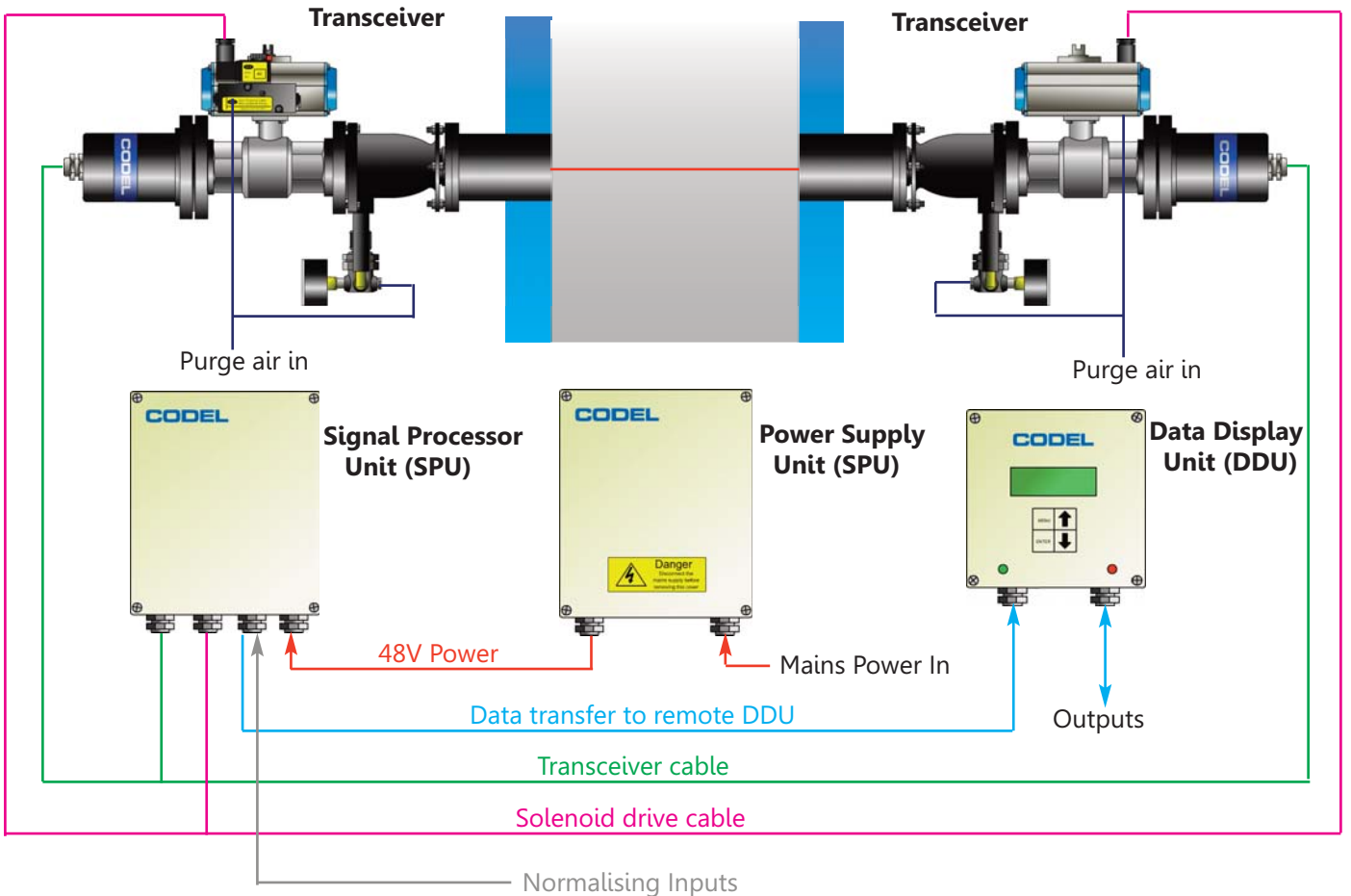

Overall Dimensions - Transceivers and Site Flanges

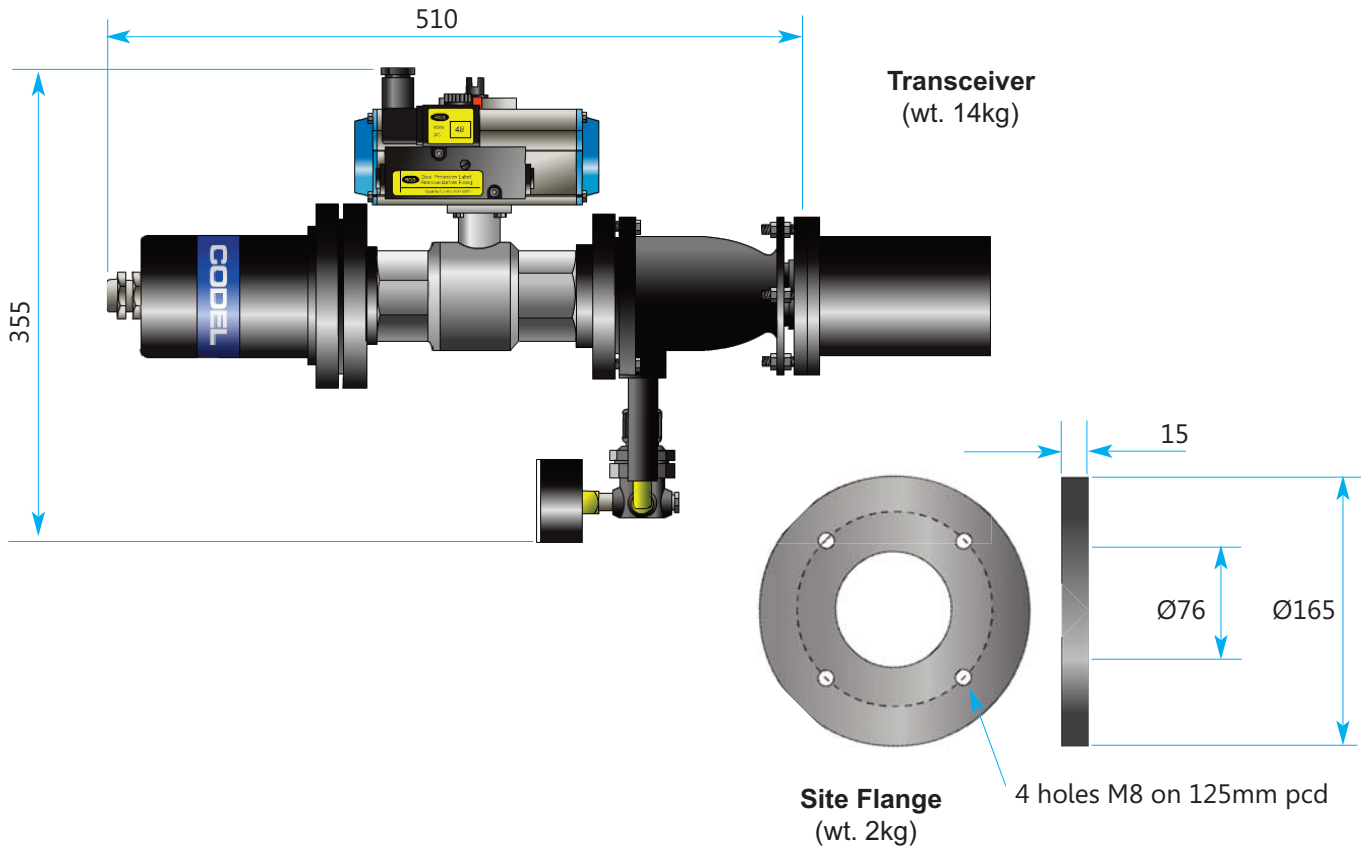

Overall Dimensions - Signal Processor (SPU) & Power Supply (PSU)

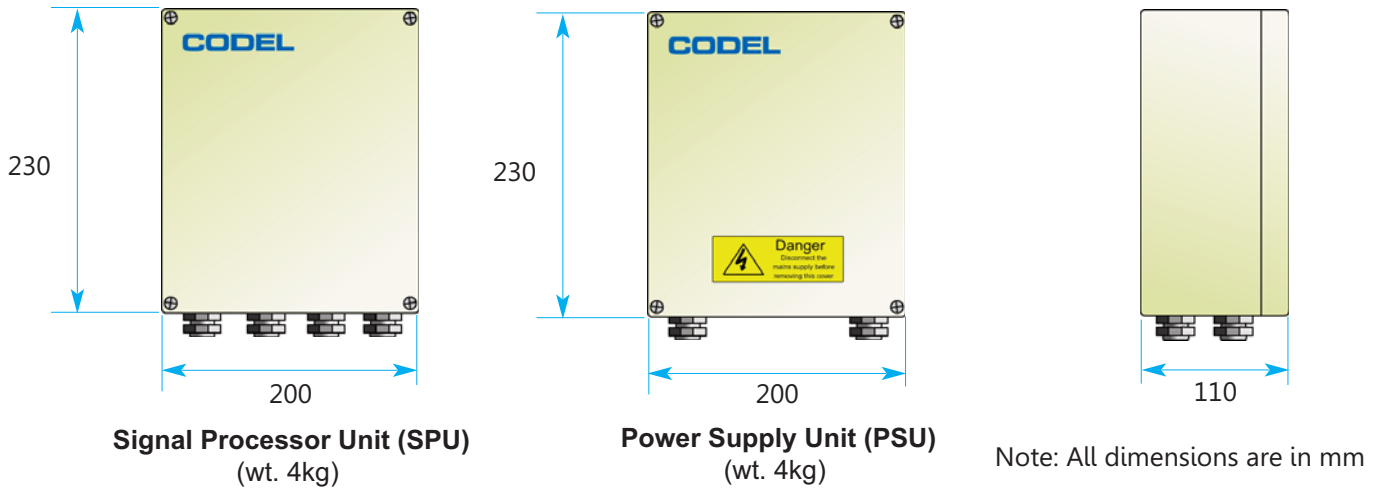

Overall Dimensions - Data Display Unit (DDU)

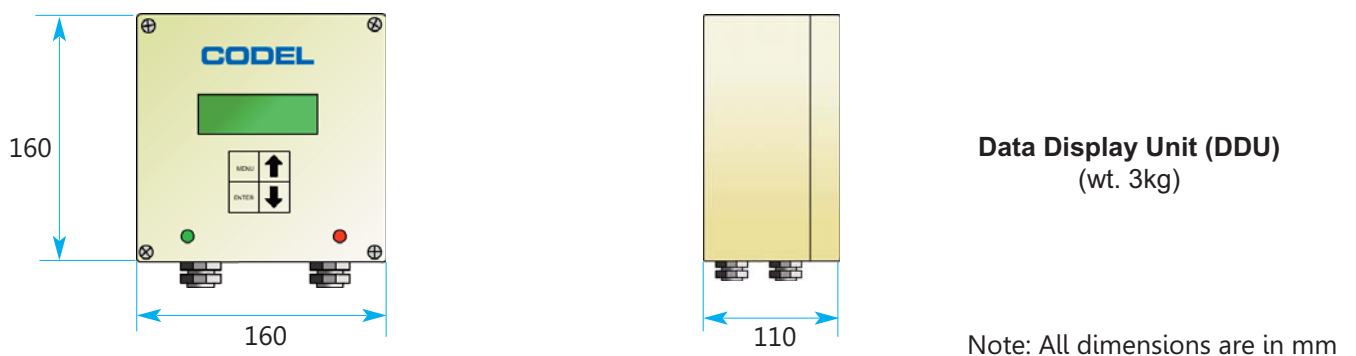

DCEM2000/2100 Operating Principle

Particles emitted from industrial processes include smoke, soot, ash and carried-over process materials. All of these particles are visible and they can be measured by looking at how much they absorb and scatter visible light.

The CODEL DCEM2000/2100 utilises two separate transceivers – each measuring across the same path. The LED light sources are turned on sequentially such that each transceiver measures either the transmitted light from its own source (I_o) or the received light from the opposing source (I_r).

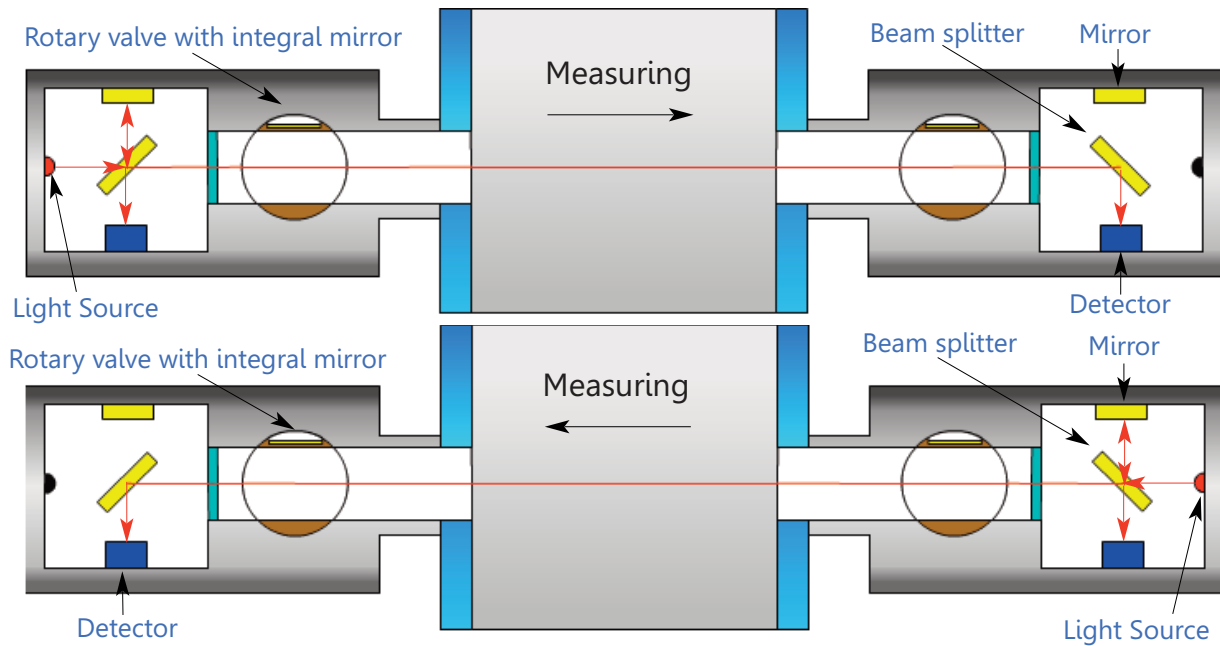

This provides the basic measurement of Transmittance where: $\text{Transmittance (T)} = \text{Received light (I}_r\text{)} / \text{Transmitted light (I}_o\text{)}$

(Any difference between the 2 measurements of Transmittance indicates misalignment)

% Opacity (Smoke Density) = $(1 - \text{Transmittance (T)}) \times 100$

Dust density can also be measured if the physical and chemical nature of the particles are constant. It is directly proportional to another function of Transmittance called Extinction where: $\text{Extinction} = \log_e (1 / \text{Transmittance (T)})$

It is vital that an empirical ratio between the measured Extinction and actual dust density is established for each application by collecting a sample of the dust under controlled conditions. The DCEM2000/2100 can then use a Dust Factor where: $\text{Dust Factor} = \text{Sampled mg/m}^3 / \text{Average Extinction during the collection}$. This Dust Factor is then used in normal operation to provide an output directly in mg/m^3 where: $\text{mg/m}^3 = \text{Dust Factor} \times \text{Measured Extinction}$

(In the absence of actual data, assume $(250/x)\text{mg/m}^3$ of dust will typically generate 10% opacity across a one metre path. This is only a general rule. It is not reliable above 20% opacity and must be verified by sampling.)

Where other measurements are available, the DCEM2000/2100 can provide normalised measurements in mg/Nm^3

Contamination correction is necessary because transmissometers cannot differentiate between solids held in suspension in the gas stream (emissions) and solids deposited on the optical surfaces (contamination). An integral retro mirror is automatically presented to each transceiver enabling full contamination correction.

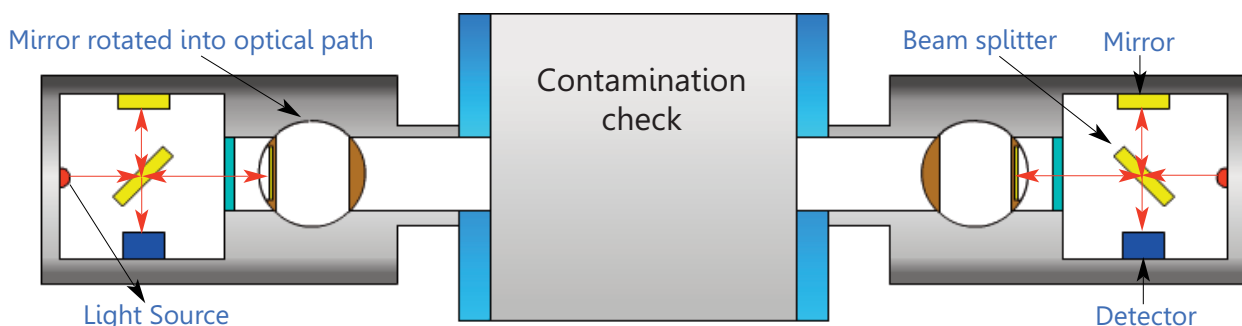

DCEM2100 Dust / Opacity Monitor - Technical Specification

Transceiver Unit

Operating Principle	Dual-pass transmissometer
Measuring units	% opacity, mg/m ³ , mg/Nm ³
Light Source	Modulated high-intensity LED at 637nm (or 580nm) wavelength *
Light Detection	Continuous measurement of transmitted and received light intensities
Optical Path Length	0.5 to 15m, longer path lengths available on request
Accuracy	+/- 0.2% opacity
Response Time	10 Seconds
Measuring Range	Fully selectable in % opacity and mg/m ³
Resolution	0.1% opacity
Drift	<1% opacity per month
Averaging	4 rolling averages selectable from 10 seconds to 30 days
Calibration	Auto zero and auto span US EPA compliant
Ambient Temperature	-20°C to +70°C
Flue Gas Temperature	850°C maximum
Power supply	48V DC from Signal Processor Unit (SPU)
Construction	Corrosion resistant epoxy coated aluminium housing sealed to IP66
Air Purge	Compressed air, 1 litre/sec @ 4bar maximum
Fail-safe Shutter	Automatic shut-off valve incase of compressed air or power failure

*US EPA Compliance requires light at 580nm; dust measurement in mg/Nm³ requires 637nm.

Signal Processor Unit (SPU)

Construction	epoxy-coated aluminium to IP67
Ambient Temperature	-20°C to +50°C
Power Supply	48V DC supplied from Power Supply Unit (PSU)
Normalising Inputs	4 x 4-20mA for oxygen, H ₂ O, Temperature & Pressure

Data Display Unit (DDU)

Analogue outputs	2 x 4-20mA current outputs as standard, isolated, 500Ω load max, fully configurable from keypad
Logic Outputs	2 x volt-free SPCO contacts, 50V, 1A max, configurable as alarm contacts 1 x volt-free SPCO contact, 50V, 1A max, for data valid signal
Logic Inputs	1 x volt free logic input for plant status or remote calibration initiation
Serial Data	RS232/RS485 MODBUS protocol (Optional)
Display	32 Character alpha-numeric back-lit LCD
Keypad	4-key soft-touch entry
Construction	epoxy-coated aluminium to IP67
Ambient Temperature	-20°C to +50°C
Power Supply	48V DC supplied from Signal Processor Unit (SPU)

Power Supply Unit (PSU)

Construction	epoxy-coated aluminium to IP67
Ambient Temperature	-20°C to +50°C
Power Supply	Mains 110 / 230 vac, single phase, 50/60hz - 48V DC output to Signal Processor Unit (SPU)

Compliances

EMC	89/336/EEC directive compliant
Low Voltage	73/23/EEC directive compliant
EN14181 QAL1	TUV Certification pending

Services

Power	Mains 110 / 230 VAC, single phase, 50/60hz 50VA
Air Requirement	Clean and dry compressed air, 1 litre/sec @ 2bar

Optional Items

Check Filter Holder	For insertion of optical Check Filter
Check Filters	20%, 40%, 60%, 80% Check Filters available

DCEM2000 Dust / Opacity Monitor - Technical Specification

Transceiver Unit

Operating Principle	Dual-pass transmissometer
Measuring units	% opacity, mg/m ³ , mg/Nm ³
Light Source	Modulated high-intensity LED at 637nm (or 580nm) wavelength *
Light Detection	Continuous measurement of transmitted and received light intensities
Optical Path Length	0.5 to 15m, longer path lengths available on request
Accuracy	+/- 0.2% opacity
Response Time	10 Seconds
Measuring Range	Fully selectable in % opacity and mg/m ³
Resolution	0.1% opacity
Drift	<1% opacity per month
Averaging	4 rolling averages selectable from 10 seconds to 30 days
Calibration	Auto zero and auto span US EPA compliant
Ambient Temperature	-20°C to +70°C
Flue Gas Temperature	850°C maximum
Power supply	48V DC from Signal Processor Unit (SPU)
Construction	Corrosion resistant epoxy coated aluminium housing sealed to IP66
Air Purge	Compressed air, 1 litre/sec @ 4bar maximum
Fail-safe Shutter	Automatic shut-off valve in case of compressed air or power failure

*US EPA Compliance requires light at 580nm; dust measurement in mg/Nm³ requires 637nm.

Signal Processor Unit (SPU)

Construction	epoxy-coated aluminium to IP67
Ambient Temperature	-20°C to +50°C
Power Supply	48V DC supplied from SmartCEM Control Panel

Outputs - from SmartCEM SCU

Analogue outputs	1 x 4-20mA current outputs as standard, isolated, 500Ω load max, fully configurable from keypad
Logic Outputs	1 x volt-free SPCO contacts, 50V, 1A max, configurable as alarm contacts 1 x volt-free SPCO contact, 50V, 1A max, for data valid signal

Compliances

EMC	89/336/EEC directive compliant
Low Voltage	73/23/EEC directive compliant
TUV	TUV Certification pending

Services

Power	48V DC from Station Control Unit (SCU) 50VA
Air Requirement	Clean and dry compressed air, 1 litre/sec @ 2bar

Optional Items

Check Filter Holder	For insertion of optical Check Filter
Check Filters	20%, 40%, 60%, 80% Check Filters available

CODEL International Ltd
Station Building
Station Road
Bakewell
Derbyshire
DE451GE
United Kingdom

Tel : +44 (0)1629 814351
Fax : +44 (0)8700 566307
Web : www.codel.co.uk
Email : sales@codel.co.uk

Distributor

	شرکت آلایرداز محیطا
تهران - خیابان آزادی - بین خیابان شادمهر و بزرگراه یادگار امام - شماره ۴۱۷ - واحد ۵	
E-mail: info@apm-co.ir	تلفن: ۰۲۱-۶۶۰۲۸۱۷۲-۵
Website: www.apm-co.ir	فکس: ۰۲۱-۶۶۰۲۰۵۰۹