



Continuous Flow Monitoring

VCEM5000/5100 Flue Gas Flow Monitor

In-situ, low maintenance devices for continuous measurement of hot gas flow

- Non-contact infra-red sensing
- Continuous measurement
- Suitable for hot and dirty gases
- No limit on upper gas temperature
- No moving components
- High availability, low maintenance requirement



- EN 15267-3 tested
- QAL1 certified
- TUV Approved
- Annual Inspection



VCEM5000/5100 Flue Gas Flow Monitor

The VCEM 5000/51000 represents the latest generation of CODEL's unique flow monitors. These systems measure the velocity of stack gases using a highly accurate time of flight measurement that is derived from a cross correlation analysis of the infra-red emissions of the turbulent gas.

Two robust infrared detectors are used for the prime sensing, mounted on the stack or duct typically 1m apart in the direction of flow. High efficiency air curtains are fitted to considerably extend the time between maintenance periods and window cleaning (typically 1 year).

This technology offers significant benefits over other types of flow measurement devices.

- › Non contact technology enables operation on hot, dusty and aggressive gases
- › It measures directly the bulk gas velocity
- › No moving components delivering low maintenance, and high measurement availability
- › Can operate at gas temperatures in excess of 1000 deg C
- › Equipped with full high and low span automated span checks

The VCEM 5100 is a standalone unit which can be easily integrated into an existing or proposed CEMS system. It includes a dedicated Data Display Unit for local data interrogation.

The VCEM 5000 is a unit dedicated for use in a CODEL SmartCEM System where all the analysers communicate via a Station Control Unit (SCU). This exports data to the CODEL SmartCEM data logging system, which displays real time data and logs data for historical analysis and regulatory reporting.

Computation of Total Pollutant Release

Legislation often demands that emission measurements are presented in mg/Nm³ where the expressed volume has been normalised to a standard temperature, pressure and oxygen concentration, and where the effects of dilution by water vapour have been removed.

To compute a measurement of the total pollutant release to atmosphere in kg/hr (or tonnes/annum), it is necessary to know:

- › The pollutant concentration in mg/m³ (mg per actual m³)
- › The hot gas flow in m/s
- › The cross sectional area at the point of measurement in m²

The total release is then calculated as follows:

Mass flow = Mass concentration x Gas velocity x Area of Duct

It is vital that all measurements are made on the same basis. Attempting to make this calculation using an actual hot wet gas flow in m/s and a normalised gas concentration in mg/Nm³ will produce significant errors.



VCEM5100 Heads



Signal Processor Unit (SPU)



Data Display Unit (DDU)

VCEM5000/5100 Operating Principle

The method used is similar in principle to the technique of flow measurement by the injection of chemical dye or radioactive tracers, where the velocity is derived from the transport time of the tracer between two measuring points a known distance apart. Instead of an artificial tracer being added, the naturally occurring turbulence of the gas stream is used as the tracer.

This flow turbulence causes fluctuations to occur in infrared radiation emitted by the gas. This continuously variable turbulent pattern is monitored by two infra red sensors mounted typically 1m apart along the direction of gas flow. An electronic correlation technique is used to continuously compare the two sensor signals to determine the time delay between them imposed by the gas velocity.

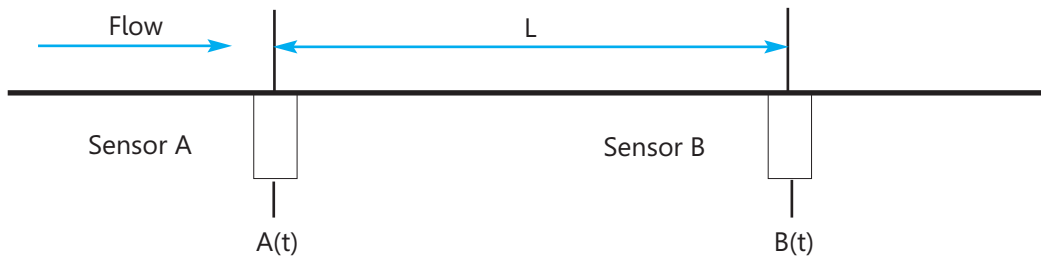

Typical signals from the sensors A and B are shown here. The signal from sensor B shows a strong similarity to that from sensor A but is delayed by a time t , the time taken for the gas to flow from point A to point B

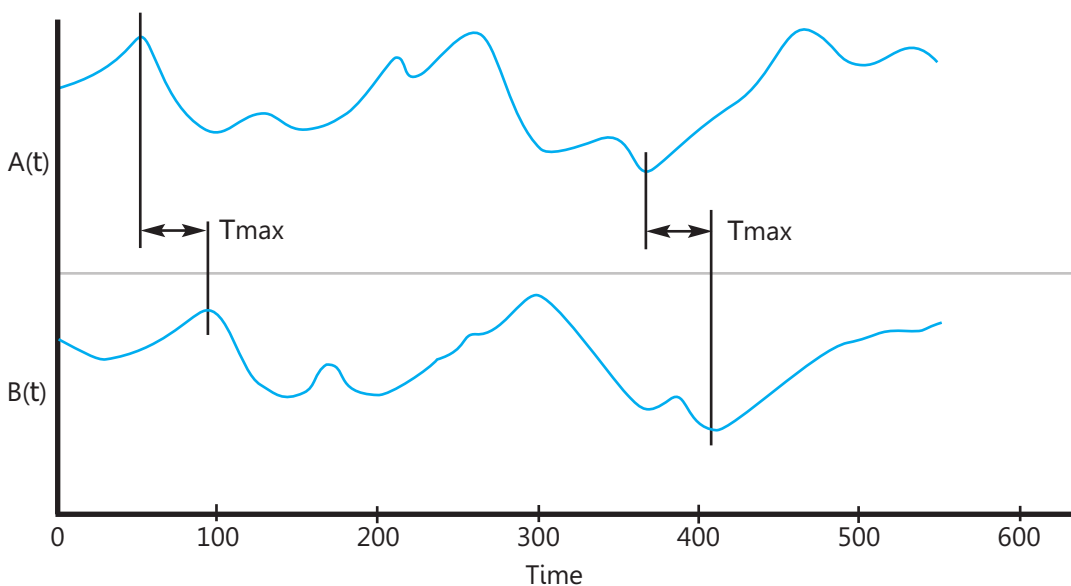

Continuous determination of the sensor signal time delay by the signal processor unit produces a continuous measurement of gas velocity since:

$$\text{Velocity } V = L/t$$

L is the separation distance between the two sensors.

VCEM5100 Flue Gas Flow Monitor - Stand Alone System Arrangement

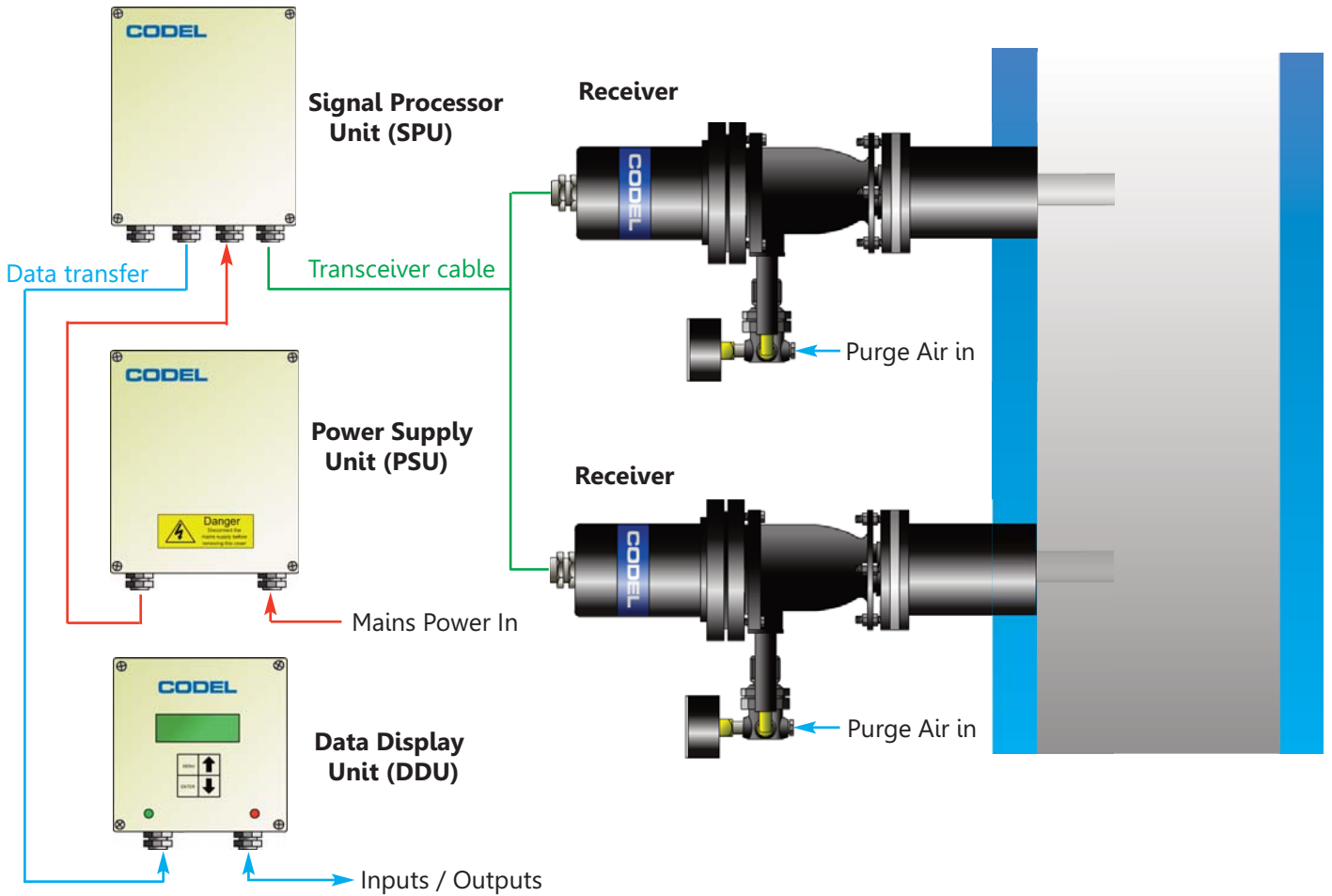

VCEM5000 Flue Gas Flow Monitor - SmartCEM Integrated System Arrangement

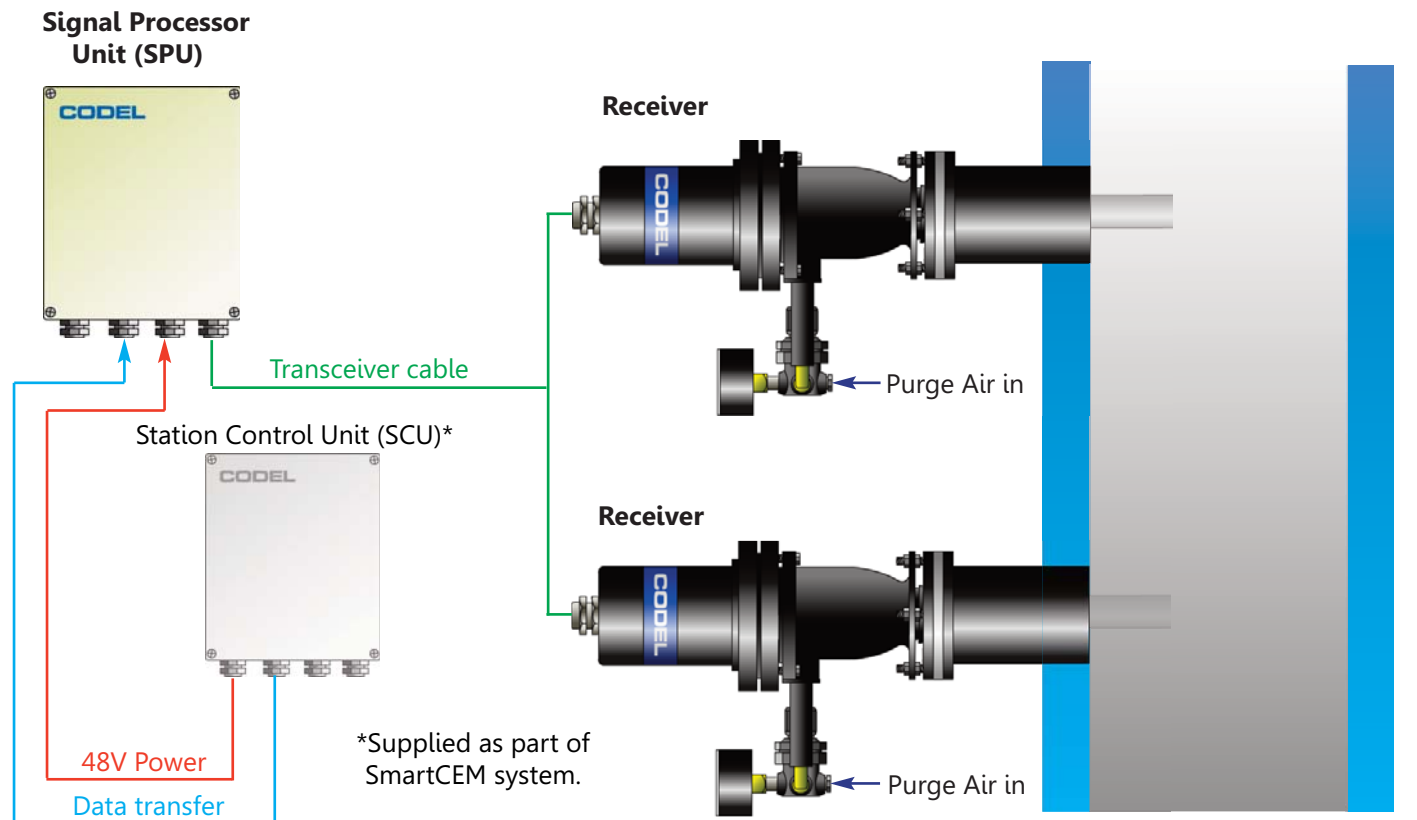

Overall Dimensions - VCEM5000/5100 & Site Flange

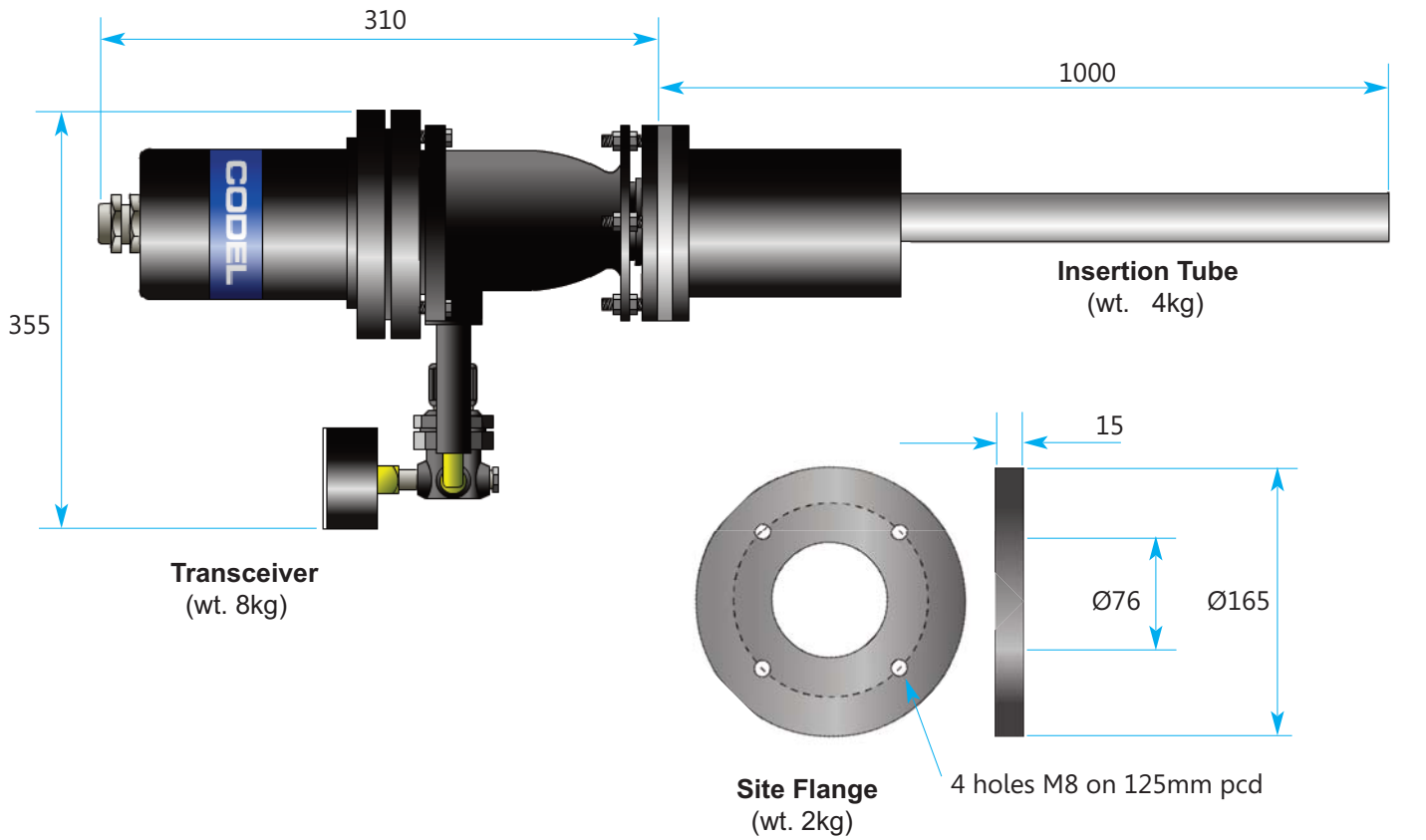

Note: All dimensions are in mm

Overall Dimensions - Signal Processor (SPU) & Power Supply (PSU)

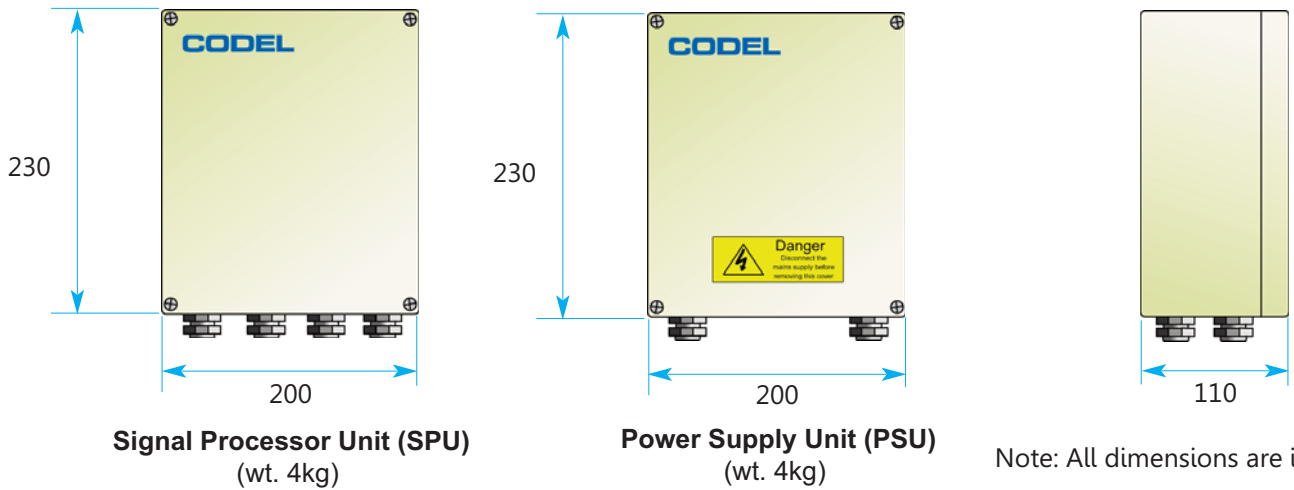

Note: All dimensions are in mm

Overall Dimensions - Data Display Unit (DDU)

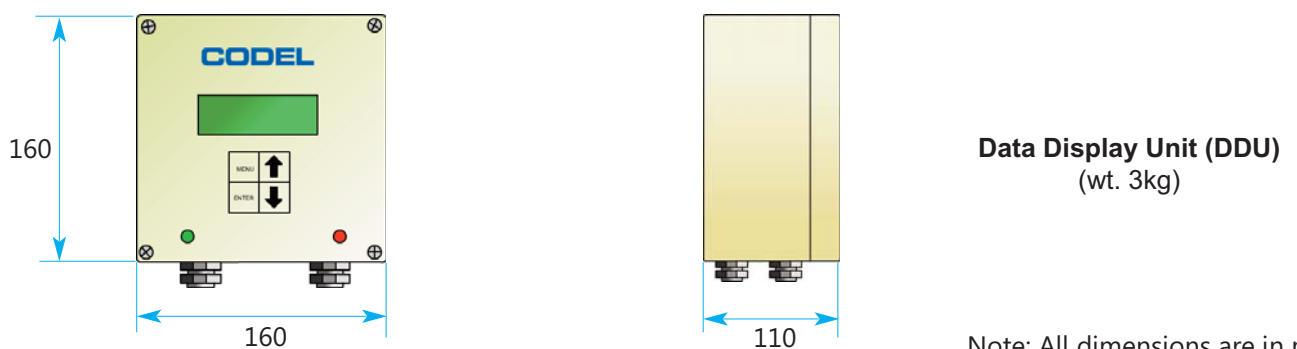

Note: All dimensions are in mm

VCEM5100 Flow Monitor - Technical Specification

Receiver Unit

Operating Principle	Infrared correlation
Measuring units	m/s, m ³ /s
Detectors	Lithium tantalate pyroelectric
Receiver separation	0.5 to 1m
For duct diameters	0.5 to 15m
Accuracy	+/- 2% of measurement
Linearity	+/- 1% of measurement
Response Time	Minimum 10 seconds
Measuring Range	Fully selectable from 0-1 up to 0-50m/s
Resolution	0.1 m/s
Drift	0.1 m/s per month
Averaging	4 rolling averages selectable from 10 seconds to 30 days
Calibration	Auto low and high span check (US EPA compliant)
Ambient Temperature	-20°C to +70°C
Flue Gas Temperature	70°C minimum, No upper limit
Power supply	48V DC from Signal Processor Unit (SPU)
Construction	Corrosion resistant epoxy coated aluminium housing sealed to IP66

Signal Processor Unit (SPU)

Construction	epoxy-coated aluminium to IP67
Ambient Temperature	-20°C to +50°C
Power Supply	48V DC supplied from Power Supply Unit (PSU)

Data Display Unit (DDU)

Analogue outputs	2 x 4-20mA current outputs as standard, isolated, 500Ω load max, fully configurable from keypad
Logic Outputs	2 x volt-free SPCO contacts, 50V, 1A max, configurable as alarm contacts 1 x volt-free SPCO contact, 50V, 1A max, for data valid signal
Serial Data	RS232/RS485 MODBUS protocol (Optional)
Display	32 Character alpha-numeric back-lit LCD
Keypad	4-key soft-touch entry
Construction	epoxy-coated aluminium to IP67
Ambient Temperature	-20°C to +50°C
Power Supply	48V DC supplied from Signal Processor Unit (SPU)

Power Supply Unit (PSU)

Construction	epoxy-coated aluminium to IP67
Ambient Temperature	-20°C to +50°C
Power Supply	Mains 110 / 230 vac, single phase, 50/60hz - 48V DC output to Signal Processor Unit (SPU)

Compliances

EMC	89/336/EEC directive compliant
Low Voltage	73/23/EEC directive compliant
TUV Certified (QAL1)	EN 15267 & EN 14181

Services

Power	Mains 110 / 230 VAC, single phase, 50/60hz
Air Requirement	Clean and dry compressed air, 1 litre/sec @ 2bar

Optional Items

Fail-safe Shutter	Automatic shut-off valve in case of compressed air or power failure
-------------------	---

VCEM5000 Flow Monitor - Technical Specification

Receiver Unit

Operating Principle	Infrared correlation
Measuring units	m/s, m ³ /s, Nm ³ /s, kg/s, tonnes/annum (when connected to a CODEL SmartCEM system)
Detectors	Lithium tantalate pyroelectric
Receiver separation	0.5 to 1m
For duct diameters	0.5 to 15m
Accuracy	+/- 2% of measurement
Linearity	+/- 1% of measurement
Response Time	Minimum 10 seconds
Measuring Range	Fully selectable from 0-1 up to 0-50m/s
Resolution	0.1 m/s
Drift	0.1 m/s per month
Averaging	4 rolling averages selectable from 10 seconds to 30 days
Calibration	Auto low and high span check (US EPA compliant)
Ambient Temperature	-20°C to +70°C
Flue Gas Temperature	70°C minimum, No upper limit
Power supply	48V DC from CODEL SmartCEM Station Control Unit (SCU)
Construction	Corrosion resistant epoxy coated aluminium housing sealed to IP66
Air Purge	Compressed air, 1 litre/sec @ 2bar

Signal Processor Unit (SPU)

Construction	epoxy-coated aluminium to IP67
Ambient Temperature	-20°C to +50°C
Power Supply	48V DC supplied from CODEL SmartCEM Station Control Unit (SCU)

Outputs from SmartCEM SCU

Analogue outputs	1 x 4-20mA current output as standard, isolated, 500Ω load max, fully configurable
Logic Outputs	1 x volt-free SPCO contacts, 50V, 1A max, configurable as alarm 1 x volt-free SPCO contact, 50V, 1A max, for data valid signal

Compliances

EMC	89/336/EEC directive compliant
Low Voltage	73/23/EEC directive compliant
TUV Certified (QAL1)	EN 15267 & EN 14181

Services

Power	Mains 110 / 230 VAC, single phase, 50/60hz
Air Requirement	Clean and dry compressed air, 1 litre/sec @ 2bar

Optional Items

Fail-safe Shutter	Automatic shut-off valve in case of compressed air or power failure
-------------------	---

CODEL International Ltd
Station Building
Station Road
Bakewell
Derbyshire
DE451GE
United Kingdom

Tel : +44 (0)1629 814351
Fax : +44 (0)8700 566307
Web : www.codel.co.uk
Email : sales@codel.co.uk

Distributor

	شرکت آلایرداز ممیبا
تهران - خیابان آزادی - بین خیابان شادمهر و بزرگراه یادگار امام - شماره ۴۱۷ - واحد ۵	
E-mail: info@apm-co.ir	تلفن: ۰۲۱-۶۶۰۲۸۱۷۲-۵
Website: www.apm-co.ir	فکس: ۰۲۱-۶۶۰۲۰۵۰۹